

TEST REPORT FOR:

Virginia Department of Transportation
ET-Plus 50' (15.24 m) System 4" Channel



TESTED TO:

NCHRP 350

Test 3-30

PREPARED FOR:

Virginia Department of Transportation
1401 E. Broad St.
Richmond, VA 23219

TEST REPORT NUMBER:

TR-P35107-01-NC

REPORT DATE:

September 29, 2015

TEST DATE:

September 18, 2015



KARCO Engineering, LLC.
Automotive and Safety Testing Facility
9270 Holly Road, Adelanto, CA 92301
Tel: (760) 246-1672 Fax: (760) 246-8112
www.KARCO.com

REVISION CONTROL LOG

TR-P35107-01

Revision	Date	Description
-NC	09/29/15	Original Test Report

TABLE OF CONTENTS

<u>Section</u>		<u>Page</u>
1	Introduction	1
2	Test Procedure and Instrumentation Summary	4
3	Test Results	7
4	Data Sheets	8
 <u>Data Sheet</u>		 <u>Page</u>
1	Test Vehicle Information	9
2	Test Vehicle Geometry	10
3	Occupant Compartment Deformation Index	11
4	Summary of Results	12
5	Crash Test Assessment	13
6	Impact Conditions	14
7	Test Data Summary	15
 <u>Appendix</u>		 <u>Page</u>
A	Photographs	A
B	Data Plots	B
C	Instrumentation	C
D	Drawings and Illustrations	D
	 Total Number of Pages	 63
	Final Page of Report	D-2

SECTION 1

INTRODUCTION

1.1 OBJECTIVES

The objective of this crash test was to determine if the impact tested Trinity Highway Products ET-Plus 50' (15.24 m) System 4" Channel meets the minimum performance standards of the National Cooperative Highway Research Program Report 350 (NCHRP 350) test 3-30 guidelines. This report presents the results of the performance and evaluation of one (1) full-scale crash test conducted on one ET-Plus 50' (15.24 m) System. For this test, the terminal section was adjoined to a 34.3 m (112.5 ft.) length of guardrail.

The test was conducted in accordance with NCHRP 350 requirements. Procedures for receiving, inspecting, testing and reporting of test results are described in the test procedure and are not repeated in this report. The purpose of this test was to evaluate the crash performance of the ET-Plus 50' (15.24 m) System.

1.2 TEST FACILITY

This test was conducted at KARCO Engineering's test facility in Adelanto, California. The tow road is a continuous level surface constructed of reinforced concrete and measures 850 ft. long by 14 ft. wide by 6 in. thick. A steel rail is embedded in the road to provide vehicle guidance. Vehicle tow propulsion is provided by a 1 ton truck using a 1-to-2 pulley system coupled to a fixed prime mover (an internal combustion engine, Chevrolet V-8, 454 cubic inches displacement, with TH-400 automatic transmission) and continuous cable drive system. The test vehicle is towed to within 25 ft. of the barrier by a nylon rope clamped to a 3/8 in. steel cable. The clamp is released from the cable on contact with a cable release mechanism positioned to allow the test vehicle to proceed under its own momentum for a maximum of 25 ft. before impacting the barrier.

1.3 TEST ARTICLE

The ET-Plus 50' (15.24 m) System 4" Channel is a guardrail terminal / end treatment. The as-tested ET-Plus 50' (15.24 m) System consisted of one (1) ET-Plus 4" Channel guardrail extruder head, one (1) Hinged Breakaway (HBA) post, seven (7) Steel Yielding Terminal Posts (SYTP), one (1) standard I-beam line post, two (2) rail panels, and one (1) cable anchor assembly. The terminal section was installed with a 50:1 Flare and a rail height ranging from 705 mm (27.75 in.) to 730 mm (28.75 in.) per Virginia Department of Transportation (VDOT) Road and Bridge Standards.

The first post of the terminal section was a Hinged Breakaway (HBA) post. The HBA post consists of two (2) parts: one (1) 1.8 m (5.8 ft.) long HBA bottom post and one (1) 0.7 m

(2.4 ft.) long (1) HBA top post. The HBA posts are constructed of W6 x 8.5 I-beam and have a set of two (2) 13 mm (0.5 in.) thick tabs welded to one end. The posts are connected to each other at the tabs by two (2) 0.375" diameter x 2" long hex head bolt, washer, lock washer, and nut; and two (2) 0.75" diameter x 2.5" long hex head bolt, washer, lock washer, and nut. The HBA bottom post is embedded in the soil foundation and the HBA top post stands above grade.

Posts 2 – 8 were Steel Yielding Terminal Posts (SYTP) and post 9 was a standard line post. All SYTP posts and the standard line post measure 1.8 m (6.0 ft.) long and are constructed of W6 x 8.5 I-beam. A 3" x 3" angle iron strut was bolted to and connected the bases of posts 1 and 2. The strut was attached to post 1 by the 0.75" diameter x 2.5" long hex head bolt, washer, lock washer, and nut which linked the HBA top post to the HBA bottom post. The strut was attached to post 2 by two (2) 0.4375" diameter x 1.5" long hex bolts, flat washers, lock washers, and nuts.

Two (2) 7.6 m (25.0 ft.) long rail panels are mounted to the posts of the terminal section with the splice located at post 5. The rail panels are constructed of 12 Ga W-beam guardrails. The first rail panel is mounted to the first SYTP post via a 0.625" diameter x 1.25" long H.G.R. bolt, washer, and nut. 191 mm (7.5 in.) plastic offset blocks are placed between the remainder of the terminal's SYTP posts and the rail panels. One (1) 0.625" diameter x 10" H.G.R. long bolt, washer, and nut is used to mount the rail to each of the SYTP posts with offset blocks. The rail is not mounted to the HBA post. The posts were spaced at a nominal distance of 1.9 m (6.25 ft.) The as-tested length of the ET-Plus 50' (15.24 m) System from post 1 to post 9 was 15.2 m (50.0 ft.).

The ET-Plus 4" Channel Guardrail Extruder Head is installed over the front rail panel and is mounted to the HBA top post by two (2) 0.375" diameter x 1.5" hex head bolts, washers, fender washers, and nuts. The cable anchor assembly anchors the rail panel to the base of the HBA post with a 19 mm (0.75 in.) thick steel cable. The upper end of the cable attaches to the rail via the cable anchor bracket which hooks onto the rail panel. The lower end of the cable is attached to the 16 mm (0.625 in.) thick bearing plate which is hooked onto the HBA post. Each end of the cable is secured by a 1" hex nut and washer which is tightened until the cable is taut.

For this test, the ET-Plus 50' (15.24 m) System was adjoined to the end of a 34.3 m (112.5 ft.) length of guardrail, measured from post 9 to post 27. The adjoining guardrail included a 3.8 m (12.5 ft.) long trailing end terminal treatment, measured from post 25 to post 27. The terminal's adjoining barrier consisted of seventeen (17) 1.8 m (6.0 ft.) long W6 x 8.5 standard I-beam line posts, one (1) 8" x 6" wood post with a soil plate and steel foundation tube, four (4) 7.6 m (25.0 ft.) long 12 Ga W-beam rail panels, one (1) 3.8 m (12.5 ft.) long 12 Ga W-beam rail panel, and one (1) cable anchor assembly. 191 mm (7.5 in.) plastic offset blocks were on all

posts except the last wooden post. All of the posts, rails, and plastic offset blocks were fastened in the same manner as the SYTP posts of the ET-Plus Terminal.

The SYTP posts and standard line posts were installed by drilling 0.3 m (1.0 ft.) diameter by 0.3 m (1.0 ft.) deep pilot holes and driving the posts into the soil. The HBA post and the trailing end terminal wooden post were installed by drilling a 0.6 m (2.0 ft.) diameter hole and backfilling and compacting the surrounding soil with a pneumatic tamper.

Photographs of the as-tested unit and installation are available in Appendix A of this report. The installation instructions are included on KARCO CD-R 2015-3620.

SECTION 2

TEST PROCEDURE AND INSTRUMENTATION SUMMARY

2.1 TEST PROCEDURE

To meet the recommended properties of the NCHRP 350 impact requirements, a commercially available production model test vehicle was selected. The test vehicle was free of major body damage, and was not missing any structural components. The bumpers were standard equipment and were not modified for this test. All fluids were drained and the battery was removed.

The NCHRP 350 recommended test vehicle properties are shown in Table 1. The 820C test vehicle was used for this test. The 820C test vehicle used for this test was a front engine model with front wheel drive and a manual transmission.

Table 1. Recommended Properties of 700C, 820C and 2000P Test Vehicles

PROPERTY	700C (Small Car)	820C (Small Car)	2000P (Pickup Truck)
MASS (kg)			
Test Inertial Dummy	700 ± 25	820 ± 25	2000 ± 45
Maximum Ballast Gross Static	75 70 775 ± 25	75 80 895 ± 25	--- 200 2000 ± 45
DIMENSIONS (cm)			
Wheelbase	230 ± 10	230 ± 10	335 ± 25
Front Overhang	75 ± 10	75 ± 10	80 ± 10
Overall Length	370 ± 20	370 ± 20	535 ± 25
Track Width (average)	135 ± 10	135 ± 10	165 ± 15
CENTER OF MASS LOCATION (cm)			
Aft of Front Axle Above Ground	80 ± 15 55 ± 5	80 ± 15 55 ± 5	140 ± 15 70 ± 5
LOCATION OF ENGINE	Front	Front	Front
LOCATION OF DRIVE AXLE	Front	Front	Rear
TYPE OF TRANSMISSION	Manual or Automatic	Manual or Automatic	Manual or Automatic

2.2 CRASH TEST SET UP

As recommended in the NCHRP 350 test procedure, a full-scale crash test was conducted to evaluate the impact performance of the ET-Plus 50' (15.24 m) System. The crash test was conducted in accordance with test designation 3-30.

2.2.1 NCHRP Report 350 Test Designation 3-30: The recommendations for test 3-30 are as follows: An 820 kg (1808 lb.) small car approaching the test article at a nominal speed of 100 km/h (62 mph), with a critical impact angle of 0° and an offset of ¼ of the test vehicle width. For this test, the test article was installed with an offset of 398 mm (15.6 in.) toward the passenger side of the vehicle.

2.3 TEST INSTRUMENTATION AND DATA ACQUISITION PROCEDURES

All testing and data acquisition for this certification test was performed in accordance with the NCHRP 350 Recommended Procedures requirements.

2.3.1 Test Vehicle Instrumentation: The test vehicle was instrumented with one (1) tri-axial accelerometer and one tri-axial angular rate sensor. Both the accelerometer and the angular rate sensor were installed within a 5 cm radial of the vehicle's longitudinal and lateral center of gravity. The accelerometers measured longitudinal (x), lateral (y) and vertical (z) acceleration. The angular rate sensors measured vehicle roll, pitch and yaw. Data was recorded using the on-board TDAS. Data was linked to a personal computer and processed using the TDAS Control software. All equipment used in this test meets the requirements of SAE J211.

2.3.1.2 Calibration: All instrumentation used in this test has been calibrated through standards traceable to NIST and is maintained in a calibrated condition.

2.3.2 TDAS Software: The software utilized in this system is written in National Instruments Lab Windows/CVI (C, Visual Interface) programming language, which is a Windows based software package with emphasis on ease of use and good engineering test practices.

2.3.3 SAE Compatibility: The software contains standard point and click processing options for selecting Society of Automotive Engineers (SAE) class post filters and calculating the required integrals, resultants, Head Injury Criteria (HIC), clips, and other data processing parameters that may be required.

2.3.4 Measurement Uncertainty: Measurement uncertainties have been determined for pertinent values affecting the results of this test. KARCO maintains these uncertainty budgets, which are available upon request, but are not included in this report. In certain cases the nature of the test method may preclude rigorous and statistically valid calculation of uncertainty of measurement. In these cases KARCO attempts to identify the components of uncertainty and make a reasonable estimation. Reasonable estimation is based on knowledge of the

performance of the method and on the measurement scope and makes use of, for example, previous experience and validation data.

2.3.5 Photographic Documentation: Photographic documentation of this test included a minimum of two (2) real-time video camera at 30 frames per second (fps), and four (4) high-speed color digital video cameras at 1000 fps All high-speed cameras were activated by a pressure-sensitive tape switch, which was positioned on the test article to indicate the instant of contact (time zero). A digital still camera was used for documenting the pre- and post-test condition of the test vehicle and the ET-Plus 50' (15.24 m) System.

2.3.6 Anthropomorphic Test Device: An uninstrumented H-III 50th percentile adult male Anthropomorphic Test Device was placed in the driver seat of the test vehicle.

SECTION 3 TEST RESULTS

3.1 TEST NO. 3-30

This 100 km/h (62 mph) impact crash test was conducted using a 2000 Geo Metro to determine if the tested traffic device meets the minimum performance standards of the NCHRP 350 recommendations for Test Level 3: Terminals and Crash Cushions. NCHRP 350 Test 3-30 is intended to evaluate controlled stopping, occupant risk, vehicle stability, and test vehicle trajectory of an 820C test vehicle.

The test article was installed at an angle of 0° relative to the test vehicle's direction of travel, with the leading edge of the W-beam rail intersecting the vehicle 398 mm toward the passenger's side of its longitudinal centerline. This crash test was documented by two (2) real-time and four (4) high-speed video cameras. Pre- and post-test photographs of the test vehicle and test article can be found in Appendix A.

Test 3-30 was conducted on September 18, 2015. The as-tested test inertial mass of the vehicle was 832.5 kg (1835.3 lbs.). The height of the front bumper was 220 mm (8.7 in.) measured to the lower edge and 543 mm (21.4 in.) measured to the upper edge. Additional dimensions and test vehicle information are presented in Data Sheets No. 1 and 2.

The test vehicle impacted the ET-Plus 50' (15.24 m) System at a velocity of 96.82 km/h (60.16 mph). The test vehicle impacted the ET-Plus extruder head and pushed it down the guardrail before stopping upstream of the third SYTP post. The HBA top post broke away from the HBA bottom post and remained attached to the extruder head. The first two (2) SYTP posts yielded at grade level and bent down to the ground and forward in the direction of vehicle travel. The third SYTP post also yielded at grade level and bent approximately 46° in the direction of vehicle travel. After the vehicle passed the second SYTP post, the guardrail panel kinked and separated at the third SYTP post and the extruder head spun to the non-traffic side of the guardrail. The vehicle spun clockwise toward the traffic side of the guard rail and impacted the rail at the third SYTP post before coming to rest. The test vehicle came to rest approximately 10.5 m (34.5 ft.) forward and 1.4 m (4.7 ft.) left of its position at the point of impact. An overhead illustration of the test vehicle and test article in their pre-test and post-test conditions is shown in Figure 57 in Appendix D. Sequential photographs of the test sequence are shown on Data Sheet 4. The remainder of the posts shifted within the soil foundation. The wooden post of the trailing end terminal treatment cracked and the cable anchor assembly was not taut after the impact.

The vehicle sustained damage to the front bumper, hood, grill, left front fender, left rear fender, and left front tire as a result of the impact with the ET-Plus 50' (15.24 m) System. The occupant compartment was not penetrated as a result of the impact.

A summary of the electronic data is presented in Data Sheet No. 7; data plots are presented in Appendix B. Data Sheet 5 shows the NCHRP Report 350 evaluation criteria and the assessment of the performance of this installation with respect to those criteria.

SECTION 4
DATA SHEETS

Test Article: ET-Plus 50' (15.24 m) System 4" Channel Project No. P35107-01
 Test Program: NCHRP 350 (3-30) Test Date: 09/18/15

CONVERSION FACTORS

Quantity	Typical Application	Std Units	Metric Unit	Multiply By
Mass	Vehicle Weight	lb	kg	0.4536
Linear Velocity	Impact Velocity	miles/hr	km/hr	1.609344
Length or Distance	Measurements	in	mm	25.4
Volume	Fuel Systems	gal	liter	3.785
Volume	Small Fluids	oz	mL	29.574
Pressure	Tire Pressures	lbf/in ²	kPa	6.895
Temperature	General Use	°F	°C	$=(T_f - 32)/1.8$
Force	Dynamic Forces	lbf	N	4.448
Moment	Torque	lbf-ft	N•m	1.355

DATA SHEET 1

TEST VEHICLE INFORMATION

Test Article: ET-Plus 50' (15.24 m) System 4" Channel Project No. P35107-01
 Test Program: NCHRP 350 (3-30) Test Date: 09/18/15

TEST VEHICLE INFORMATION

Make	Geo	Cylinders	Inline 4
Model	Metro	Engine Displacement (L)	1.0
Body Style	3-Door Hatchback	Engine Placement	Transverse
VIN	2C1MR2267Y6721145	Fuel Type	Gasoline
Color	Blue	Transmission	Manual
Odometer Reading (mi)	182,578	Final Drive	Front
Previous Damage to Vehicle	Minor dents and scratches		

DATA FROM CERTIFICATION LABEL

Manufactured By	Cami Automotive Inc. Canada	GVWR (kg)	1175
		GAWR Front (kg)	635
Date of Manufacture	Feb-00	GAWR Rear (kg)	560

TEST VEHICLE WEIGHTS

	As Received (kg)			Test Inertial (kg)			Gross Static (kg)		
	Front	Rear	Total	Front	Rear	Total	Front	Rear	Total
Left	244.0	154.0	398.0	239.5	155.5	395.0	270.5	182.5	453.0
Right	258.5	159.0	417.5	273.0	164.5	437.5	280.0	174.0	454.0
Ratio (%)	61.6	38.4	100.0	61.6	38.4	100.0	60.7	39.3	100.0
Total	502.5	313.0	815.5	512.5	320.0	832.5	550.5	356.5	907.0

	As Received (lb)			Test Inertial (lb)			Gross Static (lb)		
	Front	Rear	Total	Front	Rear	Total	Front	Rear	Total
Left	537.9	339.5	877.4	528.0	342.8	870.8	596.3	402.3	998.6
Right	569.9	350.5	920.4	601.9	362.7	964.6	617.3	383.6	1000.9
Ratio (%)	61.6	38.4	100.0	61.6	38.4	100.0	60.7	39.3	100.0
Total	1107.8	690.0	1797.8	1129.9	705.5	1835.4	1213.6	785.9	1999.5

DATA SHEET 2

TEST VEHICLE GEOMETRY

Test Article: ET-Plus 50' (15.24 m) System 4" Channel

Project No. P35107-01

Test Program: NCHRP 350 (3-30)

Test Date: 09/18/15

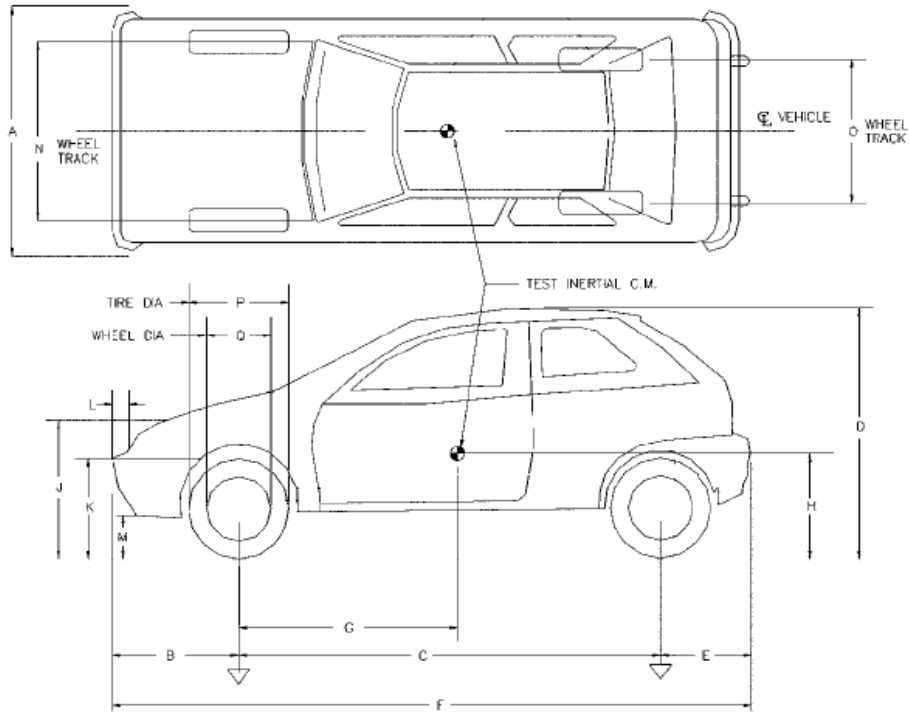

TEST VEHICLE GEOMETRY

	mm	in.		mm	in.		mm	in.		mm	in.
A	1590	62.6	E	582	22.9	J	570	22.4	N	1385	54.5
B	834	32.8	F	3772	148.5	K	543	21.4	O	1358	53.5
C	2356	92.8	G	906	35.7	L	95	3.7	P	580	22.8
D	1425	56.1	H	500	19.7	M	220	8.7	Q	355	14.0

DATA SHEET 3

OCCUPANT COMPARTMENT DEFORMATION INDEX

Test Article: ET-Plus 50' (15.24 m) System 4" Channel Project No. P35107-01
 Test Program: NCHRP 350 (3-30) Test Date: 09/18/15

The seven subindices a, b, c, d, e, f and g indicate the percentage of reduction of seven interior dimensions shown on the following figure:

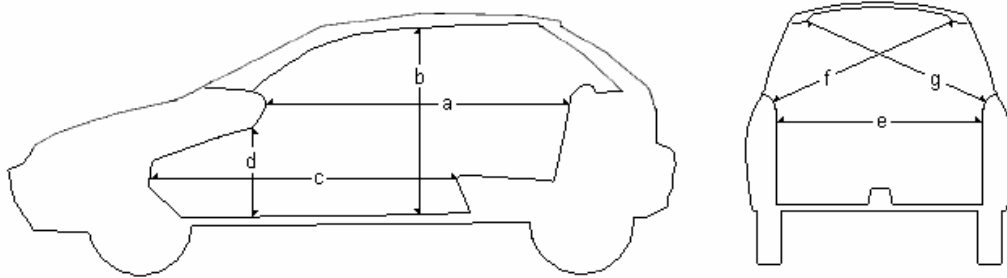

where,

- a = distance between the dashboard and a reference point at the rear of the occupant compartment, such as top of rear seat, or the rear part of the cab on a pickup;
- b = distance between the roof and the floor panel;
- c = distance between a reference point at the rear of the occupant compartment and the motor panel;
- d = distance between the lower dashboard and the floor panel;
- e = interior width;
- f = distance between the lower edge of right window and the upper edge of left window; and
- g = distance between the lower edge of left window and the upper edge of right window

Sub-Indices	Pre-Test		Post-Test		Percent Reduction
	mm	in.	mm	in.	
A	1586	62.4	1558	61.3	1.77%
B	1019	40.1	1048	41.3	-2.85%
C	1471	57.9	1470	57.9	0.07%
D	311	12.2	320	12.6	-2.89%
E	1242	48.9	1258	49.5	-1.29%
F	1158	45.6	1163	45.8	-0.43%
G	1168	46.0	1183	46.6	-1.28%
Max Deformation	311	12.2	320	12.6	-2.89%
OCDI	RF0000000				
Comments:	None				

DATA SHEET 4
SUMMARY OF RESULTS

Test Article: ET-Plus 50' (15.24 m) System 4" Channel
 Test Program: NCHRP 350 (3-30)

Project No.: P35107-01
 Test Date: 09/18/15



0 ms

250 ms

500 ms

750 ms

1000 ms

GENERAL INFORMATION		OCCUPANT RISK VALUES	
TEST AGENCY	KARCO Engineering, LLC.	FLAIL SPACE VELOCITY (m/s)	
TEST NO.	3-30	X DIRECTION	7.2
DATE	9/18/2015	Y DIRECTION	0.1
TEST ARTICLE		THIV (Optional) (m/s)	7.2
TYPE	Terminal	RIDEDOWN ACCELERATION (g)	
TERMINAL LENGTH ¹	15.2 m (50.0 ft.)	X DIRECTION	-11.0
ADJOINING BARRIER LENGTH ²	34.3 m (112.5 ft.)	Y DIRECTION	10.1
TEST VEHICLE		PHD (Optional) (g)	11.9
TYPE	Production Model	ASI (Optional)	0.78
DESIGNATION	820C	VEHICLE DAMAGE	
MODEL	2000 Geo Metro	EXTERIOR	
MASS (CURB)	815.5 kg (1797.8 lbs)	VDS	12-FC-4
MASS (TEST INERTIAL)	832.5 kg (1835.4 lbs)	CDC	12FZEW1
DUMMY MASS	76.0 kg (167.5 lbs)	INTERIOR	
MASS (GROSS STATIC)	907.0 kg (1999.5 lbs)	OCDI	RF0000000
IMPACT CONDITIONS		POST-IMPACT VEHICULAR BEHAVIOR	
VELOCITY (km/h)	96.82 km/h (60.16 mph)	MAXIMUM ROLL ANGLE (°)	-5.7 ³
ANGLE (°)	0.5	MAXIMUM PITCH ANGLE (°)	-2.4 ³
IMPACT SEVERITY (kJ)	301.0	MAXIMUM YAW ANGLE (°)	186.0 ³

¹ Terminal Length measured from Post 1 to Post 9

² Adjoining Barrier Length measured from Post 9 to Post 27

³ Maximum angles recorded during the first 1.0 s of the impact event

DATA SHEET 5

CRASH TEST ASSESSMENT

Test Article: ET-Plus 50' (15.24 m) System 4" Channel

Project No. P35107-01

Test Program: NCHRP 350 (3-30)

Test Date: 09/18/15

TEST VEHICLE EVALUATION CRITERIA

EVALUATION FACTOR	EVALUATION CRITERIA	ASSESSMENT	NOTES				
OCCUPANT RISK	C Acceptable test article performance may be by redirection, controlled penetration, or controlled stopping of the test vehicle.	PASS	The test vehicle came to a controlled stop.				
	D Detached elements, fragments or other debris from the test article should not penetrate or show potential for penetrating the occupant compartment, or present an undue hazard to other traffic, pedestrians, or personnel in a work zone. Deformations of, or intrusions into, the occupant compartment that could cause serious injuries should not be permitted.	PASS	The test vehicle was not penetrated during the impact test.				
	F The vehicle should remain upright during and after collision although moderate roll, pitching and yawing are acceptable.	PASS	The vehicle remained upright during and after the impact event.				
	H Longitudinal and lateral occupant impact velocities should satisfy the following: <table border="1" style="margin-left: 20px;"> <tr> <td>Preferred</td> <td>Max</td> </tr> <tr> <td>9</td> <td>12</td> </tr> </table>	Preferred	Max	9	12	PASS	Occupant impact velocity was calculated as 7.2 m/s in the longitudinal direction and 0.1 m/s in the lateral direction
	Preferred	Max					
9	12						
I Longitudinal and lateral occupant ridedown accelerations should satisfy the following: <table border="1" style="margin-left: 20px;"> <tr> <td>Preferred</td> <td>Max</td> </tr> <tr> <td>15</td> <td>20</td> </tr> </table>	Preferred	Max	15	20	PASS	Occupant ridedown acceleration was calculated as -11.0 g in the longitudinal direction and 10.1 g in the lateral direction	
Preferred	Max						
15	20						
VEHICLE TRAJECTORY	K After collision it is preferable that the vehicle's trajectory not intrude into adjacent traffic lanes.	PASS	The test vehicle did not intrude into adjacent lanes.				
	N Vehicle trajectory behind the test article is acceptable.	PASS	The test vehicle came to rest approximately 10.5 m (34.5 ft.) forward and 1.4 m (4.7 ft.) left of its position at the point of impact.				

OVERALL IMPACT TEST ASSESSMENT

PASS

DATA SHEET 6
IMPACT CONDITIONS

Test Article: ET-Plus 50' (15.24 m) System 4" Channel Project No. P35107-01
Test Program: NCHRP 350 (3-30) Test Date: 09/18/15

Item	Value
Test Time	2:46 PM
Temperature (°C)	27.8 *
Wind Velocity (km/h)	13.0 *
Wind Direction	N *
Impact Speed (km/h)	96.82

* - Information provided for reference only

DATA SHEET 7

TEST DATA SUMMARY

Test Article: ET-Plus 50' (15.24 m) System 4" Channel

Project No. P35107-01

Test Program: NCHRP 350 (3-30)

Test Date: 09/18/15

TEST VEHICLE DATA SUMMARY

Tested Parameter	Axis	Units	Max	Time (ms)	Min	Time (ms)
Vehicle Impact Velocity	X	m/s	26.9			
Flail Space Velocity	X	m/s	7.2	137.0		
Flail Space Velocity	Y	m/s	0.1	137.0		
Ridedown Acceleration	X	g	1.8	539.7	-11.0	212.2
Ridedown Acceleration	Y	g	10.1	470.6	-1.6	230.9

TEST VEHICLE ACCELEROMETER PEAK DATA

Location	Axis	Units	Max	Time (ms)	Min	Time (ms)
Vehicle CG	X	g	2.9	531.5	-21.5	32.6
Vehicle CG	Y	g	12.0	464.1	-9.8	27.5
Vehicle CG	Z	g	20.8	28.8	-15.4	35.7

**APPENDIX A
PHOTOGRAPHS**

LIST OF PHOTOGRAPHS

Figure		Page
1	Test Article, As-Received	A-1
2	Test Article, As-Received	A-1
3	Test Vehicle, As-Received	A-2
4	Test Vehicle, As-Received	A-2
5	Test Setup	A-3
6	Test Setup Close-Up	A-3
7	Test Setup	A-4
8	Test Setup Close-Up	A-4
9	Test Setup	A-5
10	Test Setup Close-Up	A-5
11	Test Setup	A-6
12	Test Setup Close-Up	A-6
13	Test Setup	A-7
14	Test Setup Close-Up	A-7
15	Pre-Test	A-8
16	Post-Test	A-8
17	Post-Test	A-9
18	Post-Test	A-9
19	Pre-Test Front View of Test Article	A-10
20	Post-Test Front View of Test Article	A-10
21	Pre-Test Right Front $\frac{3}{4}$ View of Test Article	A-11
22	Post-Test Right Front $\frac{3}{4}$ View of Test Article	A-11
23	Pre-Test Right View of Test Article	A-12
24	Post-Test Right View of Test Article	A-12
25	Pre-Test Right Rear $\frac{3}{4}$ View of Test Article	A-13
26	Post-Test Right Rear $\frac{3}{4}$ View of Test Article	A-13
27	Pre-Test Rear View of Test Article	A-14
28	Post-Test Rear View of Test Article	A-14
29	Pre-Test Left Rear $\frac{3}{4}$ View of Test Article	A-15
30	Post-Test Left Rear $\frac{3}{4}$ View of Test Article	A-15
31	Pre-Test Left View of Test Article	A-16
32	Post-Test Left View of Test Article	A-16
33	Pre-Test Left Front $\frac{3}{4}$ View of Test Article	A-17
34	Post-Test Left Front $\frac{3}{4}$ View of Test Article	A-17

LIST OF PHOTOGRAPHS ... (CONTINUED)

Figure		Page
35	Pre-Test Left View of Test Vehicle	A-18
36	Post-Test Left View of Test Vehicle	A-18
37	Pre-Test Left Front $\frac{3}{4}$ View of Test Vehicle	A-19
38	Post-Test Left Front $\frac{3}{4}$ View of Test Vehicle	A-19
39	Pre-Test Front View of Test Vehicle	A-20
40	Post-Test Front View of Test Vehicle	A-20
41	Pre-Test Right Front $\frac{3}{4}$ View of Test Vehicle	A-21
42	Post-Test Right Front $\frac{3}{4}$ View of Test Vehicle	A-21
43	Pre-Test Right View of Test Vehicle	A-22
44	Post-Test Right View of Test Vehicle	A-22
45	Pre-Test View of Windshield	A-23
46	Post-Test View of Windshield	A-23
47	Pre-Test View of Driver's Side Occupant Compartment	A-24
48	Post-Test View of Driver's Side Occupant Compartment	A-24
49	Pre-Test View of Driver's Side Floorpan	A-25
50	Post-Test View of Driver's Side Floorpan	A-25
51	Pre-Test View of Passenger's Side Occupant Compartment	A-26
52	Post-Test View of Passenger's Side Occupant Compartment	A-26
53	Pre-Test View of Passenger's Side Floorpan	A-27
54	Post-Test View of Passenger's Side Floorpan	A-27
55	Test Vehicle Manufacturer's Label	A-28



FIGURE 1. Test Article, As Received



FIGURE 2. Test Article, As Received



FIGURE 3. Test Vehicle, As Received



FIGURE 4. Test Vehicle, As Received



FIGURE 5. Test Setup



FIGURE 6. Test Setup Close-Up



FIGURE 7. Test Setup



FIGURE 8. Test Setup Close-Up



FIGURE 9. Test Setup



FIGURE 10. Test Setup Close-Up



FIGURE 11. Test Setup



FIGURE 12. Test Setup Close-Up



FIGURE 13. Test Setup



FIGURE 14. Test Setup Close-Up



FIGURE 15. Pre-Test



FIGURE 16. Post-Test



FIGURE 17. Post-Test



FIGURE 18. Post-Test



FIGURE 19. Pre-Test Front View of Test Article



FIGURE 20. Post-Test Front View of Test Article



FIGURE 21. Pre-Test Right Front $\frac{3}{4}$ View of Test Article



FIGURE 22. Post-Test Right Front $\frac{3}{4}$ View of Test Article



FIGURE 23. Pre-Test Right View of Test Article



FIGURE 24. Post-Test Right View of Test Article



FIGURE 25. Pre-Test Right Rear $\frac{3}{4}$ View of Test Article



FIGURE 26. Post-Test Right Rear $\frac{3}{4}$ View of Test Article



FIGURE 27. Pre-Test Rear View of Test Article



FIGURE 28. Post-Test Rear View of Test Article



FIGURE 29. Pre-Test Left Rear $\frac{3}{4}$ View of Test Article



FIGURE 30. Post-Test Left Rear $\frac{3}{4}$ View of Test Article



FIGURE 31. Pre-Test Left View of Test Article



FIGURE 32. Post-Test Left View of Test Article



FIGURE 33. Pre-Test Left Front $\frac{3}{4}$ View of Test Article



FIGURE 34. Post-Test Left Front $\frac{3}{4}$ View of Test Article



FIGURE 35. Pre-Test Left View of Test Vehicle



FIGURE 36. Post-Test Left View of Test Vehicle



FIGURE 37. Pre-Test Left Front $\frac{3}{4}$ View of Test Vehicle



FIGURE 38. Post-Test Left Front $\frac{3}{4}$ View of Test Vehicle



FIGURE 41. Pre-Test Right Front ¾ View of Test Vehicle



FIGURE 42. Post-Test Right Front ¾ View of Test Vehicle



FIGURE 43. Pre-Test Right View of Test Vehicle



FIGURE 44. Post-Test Right View of Test Vehicle



FIGURE 45. Pre-Test View of Windshield



FIGURE 46. Post-Test View of Windshield



FIGURE 47. Pre-Test View of Driver's Side Occupant Compartment



FIGURE 48. Post-Test View of Driver's Side Occupant Compartment



FIGURE 49. Pre-Test View of Driver's Side Floorpan



FIGURE 50. Post-Test View of Driver's Side Floorpan



FIGURE 51. Pre-Test View of Passenger's Side Occupant Compartment



FIGURE 52. Post-Test View of Passenger's Side Occupant Compartment



FIGURE 53. Pre-Test View of Passenger's Floorpan



FIGURE 54. Post-Test View of Passenger's Floorpan



FIGURE 55. Test Vehicle Manufacturer's Label

**APPENDIX B
DATA PLOTS**

LIST OF DATA PLOTS

<u>Plot</u>		<u>Page</u>
1	Test Vehicle CG X	B-1
2	Test Vehicle CG X Moving Average	B-1
3	Test Vehicle CG X Velocity	B-1
4	Test Vehicle CG X Displacement	B-1
5	Test Vehicle CG Y	B-2
6	Test Vehicle CG Y Moving Average	B-2
7	Test Vehicle CG Y Velocity	B-2
8	Test Vehicle CG Y Displacement	B-2
9	Test Vehicle CG Z	B-3
10	Test Vehicle Accident Severity Index	B-3
11	Test Vehicle Roll Angle	B-4
12	Test Vehicle Yaw Angle	B-4
13	Test Vehicle Pitch Angle	B-4

Test Article: ET-Plus 50' (15.24 m) System 4" Channel
 Test Program: NCHRP 350 (3-30)

Project No: P35107-01
 Test Date.: 9/18/15

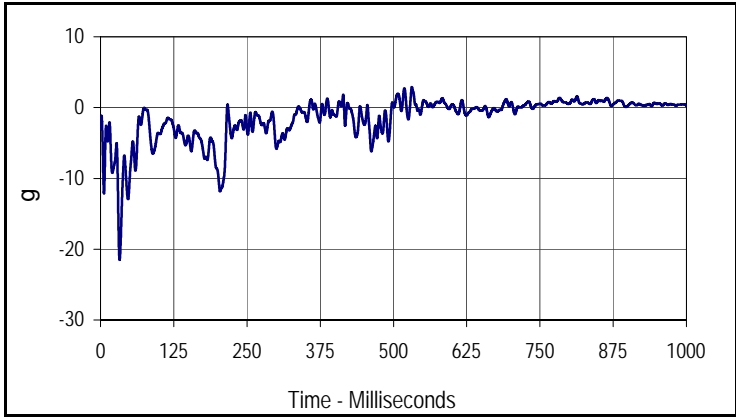

Curve Description			
Test Vehicle CG X			
Plot No.	Type	SAE Class	Units
001	FIL	60	g
Max	Time	Min	Time
2.9	531.5	-21.5	32.6

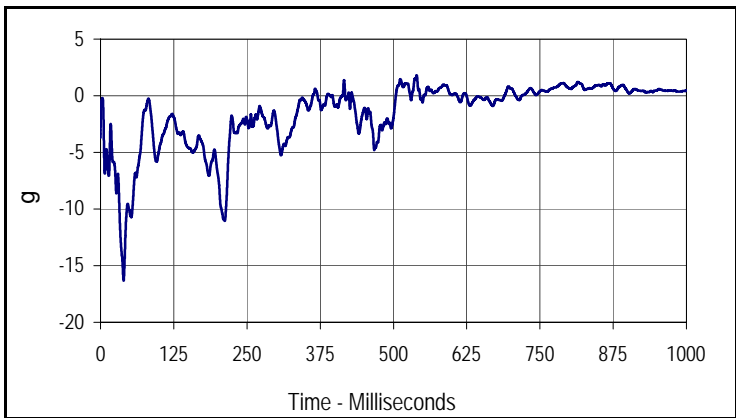

Curve Description			
Test Vehicle CG X Moving Average			
Plot No.	Type	SAE Class	Units
002	AVG	180	g
Max	Time	Min	Time
1.8	539.7	-16.3	39.5

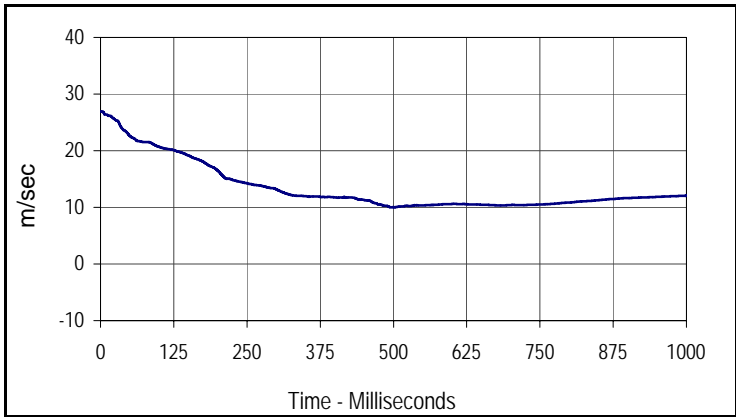

Curve Description			
Test Vehicle CG X Velocity			
Plot No.	Type	SAE Class	Units
003	IN1	180	m/sec
Max	Time	Min	Time
26.9	0.0	10.0	496.4

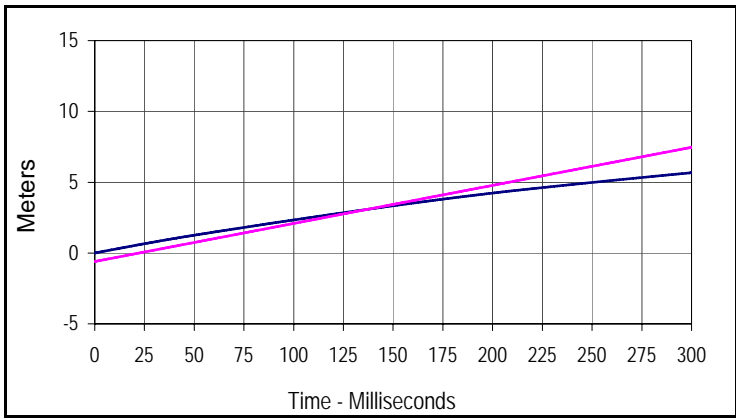

Curve Description			
Test Vehicle CG X Displacement			
Plot No.	Type	SAE Class	Units
004	IN2	180	Meters
Max	Time	Min	Time
13.4	999.9	0.0	0.0

— Vehicle CG X Displacement
 — Occupant X Displacement

Test Article: ET-Plus 50' (15.24 m) System 4" Channel
 Test Program: NCHRP 350 (3-30)

Project No: P35107-01
 Test Date.: 9/18/15

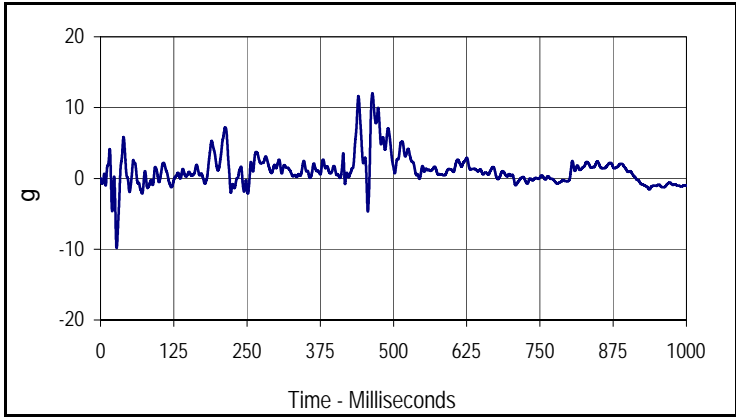

Curve Description			
Test Vehicle CG Y			
Plot No.	Type	SAE Class	Units
005	FIL	60	g
Max	Time	Min	Time
12.0	464.1	-9.8	27.5

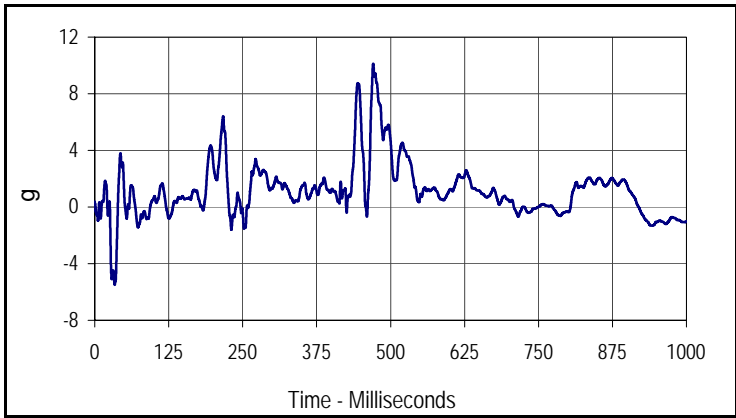

Curve Description			
Test Vehicle CG Y Moving Average			
Plot No.	Type	SAE Class	Units
006	AVG	180	g
Max	Time	Min	Time
10.1	470.6	-5.5	33.8

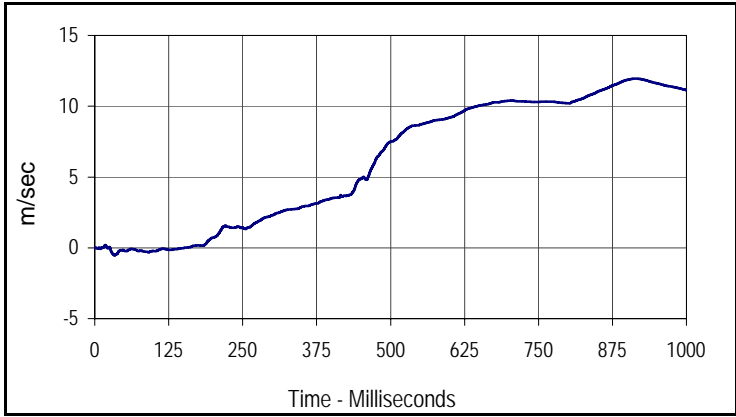

Curve Description			
Test Vehicle CG Y Velocity			
Plot No.	Type	SAE Class	Units
007	IN1	180	m/sec
Max	Time	Min	Time
11.9	914.1	-0.5	33.1

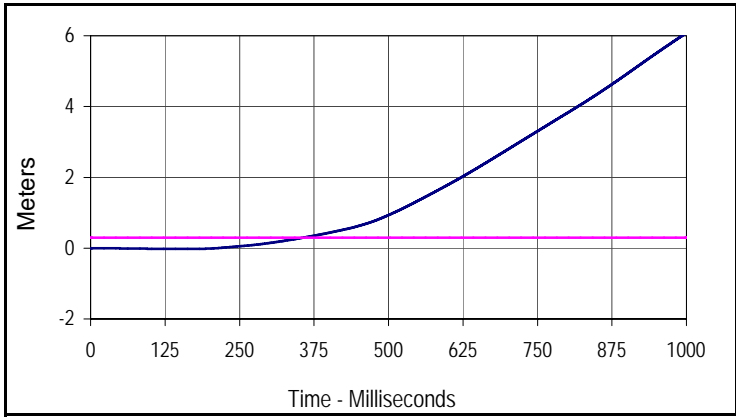

Curve Description			
Test Vehicle CG Y Displacement			
Plot No.	Type	SAE Class	Units
008	IN2	180	Meters
Max	Time	Min	Time
6.1	999.9	0.0	151.5

— Vehicle CG Y Displacement
 — Occupant Y Displacement

Test Article: ET-Plus 50' (15.24 m) System 4" Channel
 Test Program: NCHRP 350 (3-30)

Project No: P35107-01
 Test Date.: 9/18/15

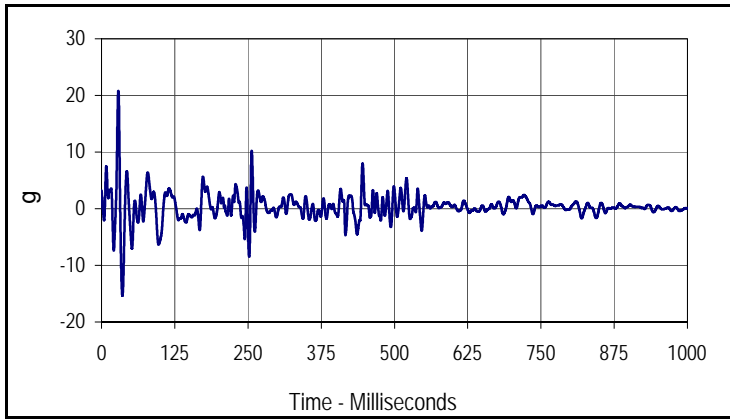

Curve Description			
Test Vehicle CG Z			
Plot No.	Type	SAE Class	Units
009	FIL	60	g
Max	Time	Min	Time
20.8	28.8	-15.4	35.7

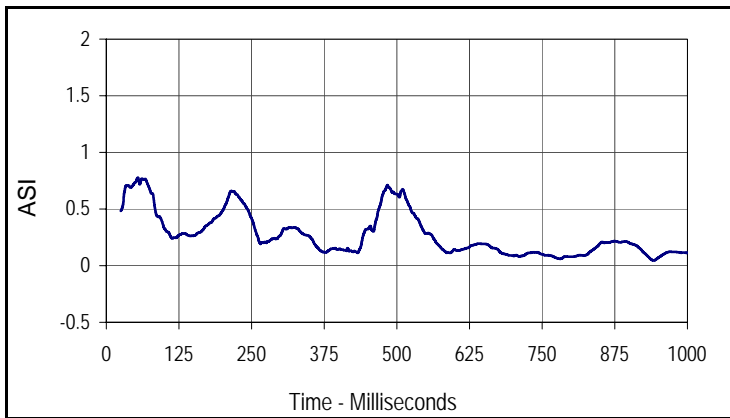

Curve Description			
Test Vehicle Accident Severity Index			
Plot No.	Type	SAE Class	Units
010	ASI	180	ASI
Max	Time	Min	Time
0.8	54.3	0.0	942.0

Test Article: ET-Plus 50' (15.24 m) System 4" Channel
 Test Program: NCHRP 350 (3-30)

Project No: P35107-01
 Test Date.: 9/18/15

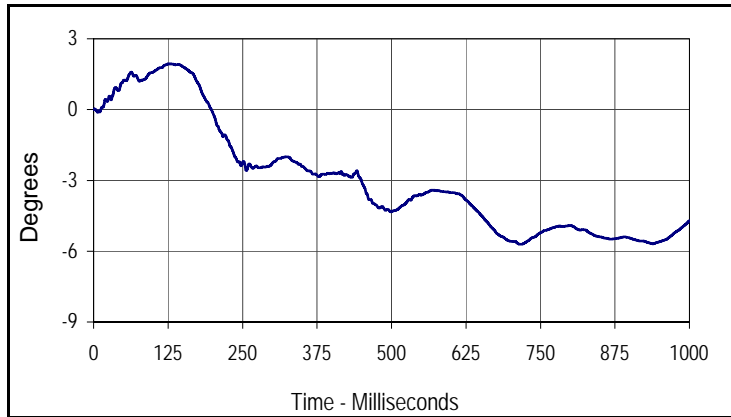

Curve Description			
Test Vehicle Roll Angle			
Plot No.	Type	SAE Class	Units
011	IN1	180	Degrees
Max	Time	Min	Time
1.9	129.3	-5.7	717.9

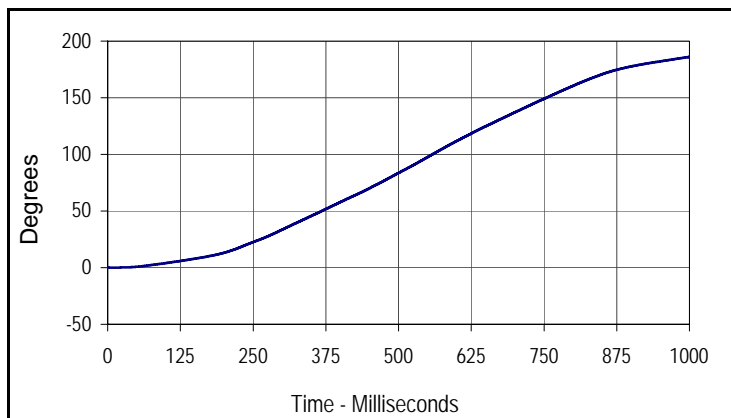

Curve Description			
Test Vehicle Yaw Angle			
Plot No.	Type	SAE Class	Units
012	IN1	180	Degrees
Max	Time	Min	Time
186.0	999.9	0.0	5.1

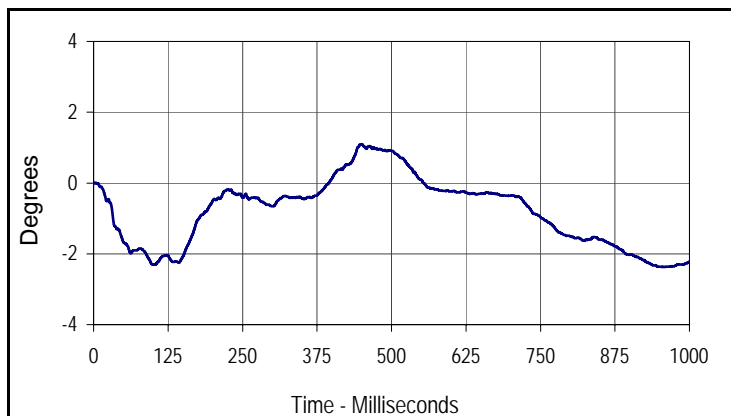

Curve Description			
Test Vehicle Pitch Angle			
Plot No.	Type	SAE Class	Units
013	IN1	180	Degrees
Max	Time	Min	Time
1.1	449.9	-2.4	958.5

**APPENDIX C
INSTRUMENTATION**

DATA ACQUISITION INFORMATION

Test Article: ET-Plus 50' (15.24 m) System 4" Channel Project No. P35107-01
Test Program: NCHRP 350 (3-30) Test Date: 09/18/15

VEHICLE INSTRUMENTATION

CH	Location	Axis	Ident. No.	Description	MFR	Model	Units
1	Vehicle CG	X	J48139	Accel, Half Bridge	Endevco	2000G	g
2	Vehicle CG	Y	J48135	Accel, Half Bridge	Endevco	2000G	g
3	Vehicle CG	Z	J48123	Accel, Half Bridge	Endevco	2000G	g
4	Vehicle CG	Yaw	ARS8486	Rate Gyro	DTS	ARS-18K	Deg/s
5	Vehicle CG	Pitch	ARS8532	Rate Gyro	DTS	ARS-18K	Deg/s
6	Vehicle CG	Roll	ARS8537	Rate Gyro	DTS	ARS-18K	Deg/s

APPENDIX D
MANUFACTURER DOCUMENTS

LIST OF FIGURES

<u>Figure</u>		<u>Page</u>
56	Manufacturer's Drawing	D-1
57	Overhead Illustration	D-2

ET- PLUS™
50' (15.24 m) System
 FOR SPECIFIC DETAILS, REFER TO THE TRINITY ET
 DRAWING(S)
 AND THE STATE STANDARD DRAWING(S)

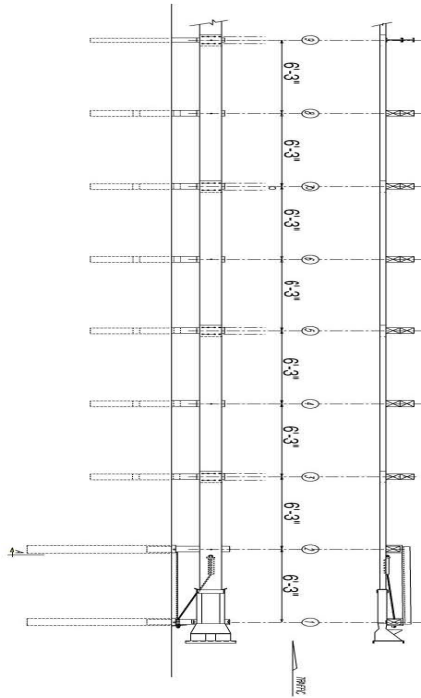

(This represents 1 version of the 50' (15.24 m) system)

NOTES:

1. Alternate to long foundation tube without soil plate is short tube with soil plate at locations 1 and 2, Hinged Breakaway (HBA) Post™ at locations 1 and 2, or Hinged Breakaway (HBA) Post™ at location 1 and Steel Yielding Terminal Post™ (SYTP) at location 2; long foundation tube or short tube with soil plate at location 1 and SYTP at location 2.
2. Alternate to two 12'6" (3.81 m) long rail elements is one 25'0" (7.62 m) long rail element.
3. Short steel foundation tubes without soil plates and breakaway wood posts, or Hinged Breakaway (HBA) Post™ may be specified for locations 3 and 4. Controlled Release Terminal (CRT) posts can be used for post locations 5 through 8.
4. Alternates to Note 3 combinations for locations 3 through 8 are: 1) All short tubes without soil plates and breakaway wood posts; 2) All HBA posts; 3) All CRT posts; 4) All SYTP.

FIGURE 56. Manufacturer's Drawing

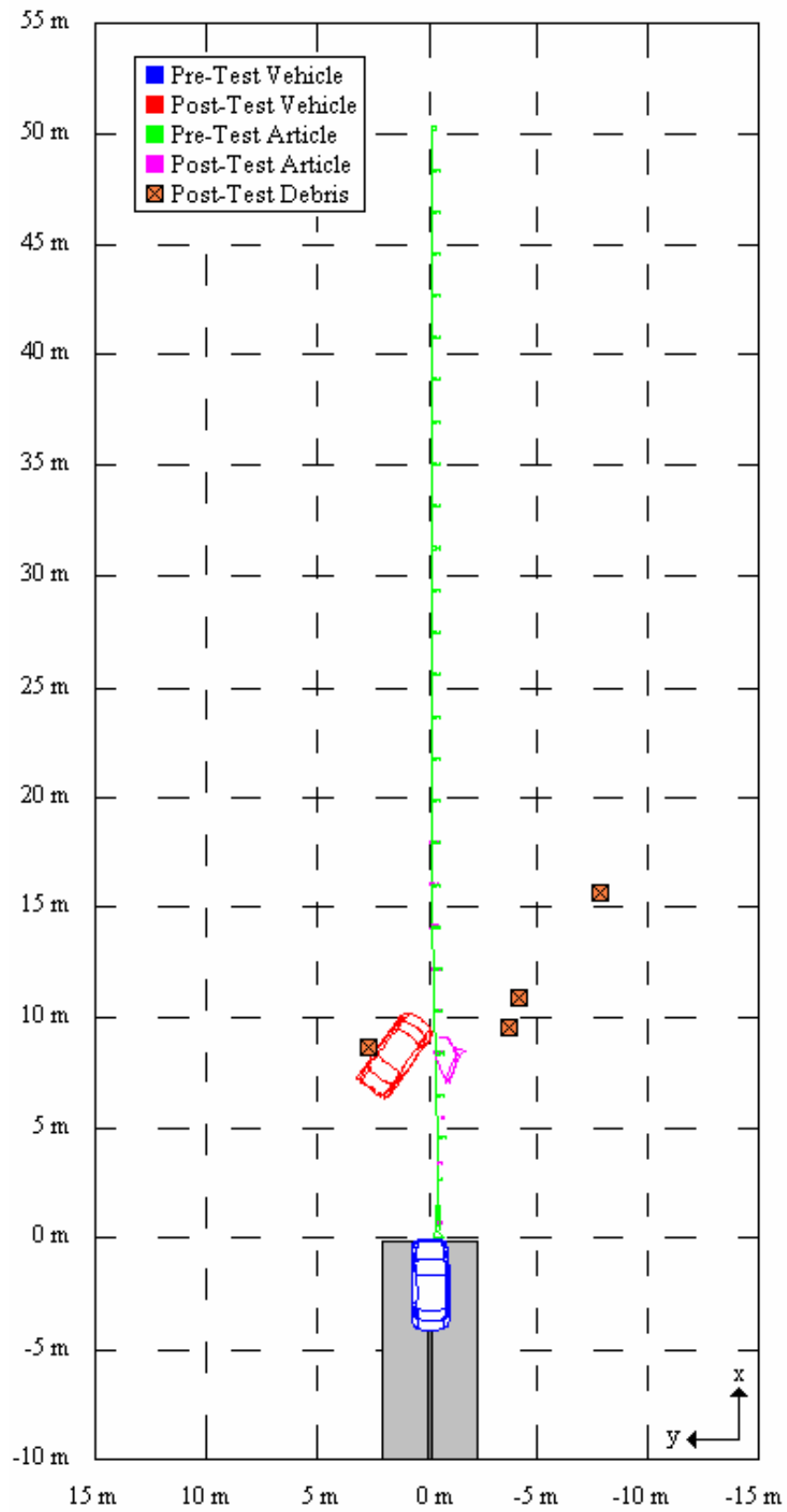

FIGURE 57. Overhead Illustration

FINAL PAGE OF REPORT